



## Thule Rapid System Kit 1503

# > Instructions

- FORD Fiesta**, 3-dr Hatchback, 08-
- FORD Fiesta Van**, 3-dr Hatchback, 08-
- FORD Fiesta**, 5-dr Hatchback, 08-
- FORD Fiesta**, 4-dr Sedan, \*11-
- FORD Fiesta**, 5-dr Hatchback, \*11-

\*North America

The diagram is divided into four main sections:

- Top Left:** An information icon (i) and a warning triangle (⚠) are shown. An arrow points to a person reading a manual. Below this, a pencil is shown writing on a document. Two manuals are shown: one labeled 'B' (Thule Rapid System Kit 1503) and one labeled 'A' (Thule Rapid System 754). An arrow points from manual B to manual A.
- Top Right:** A weight calculation diagram. It shows a bag labeled 'xx kg xx lbs' plus a bar labeled '7 kg 15,4 lbs' and two screws labeled '3 kg 6,6 lbs'. Below this, an equals sign leads to a box with 'Max. 40 kg' and 'Max. 88 lbs'.
- Bottom Left:** A warning triangle (⚠) is shown. Three manuals are shown: 'A' (Thule Rapid System 754), 'B' (Thule Rapid System Kit 1503), and 'Security'. An arrow points to a person reading a manual.
- Bottom Right:** A warning triangle (⚠) is shown. An arrow points to a car with a roof rack. A speedometer is shown with a warning triangle (⚠) in the red zone. The speedometer has markings for 40 km/h (25 Mph), 80 km/h (50 Mph), and 130 km/h (80 Mph).

ISO 11154-E

141503  
C.20141010  
519-1503-03

Bring your life  
thule.com

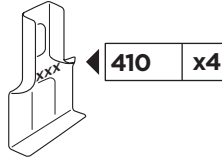
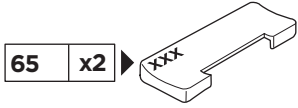
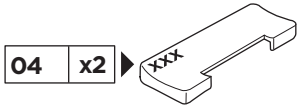

x1

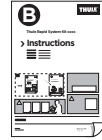

x1

1

	X (scale)	X (mm)	X (inch)
<b>FORD Fiesta, 3-dr Hatchback, 08-</b>	<b>34</b>	<b>991</b>	<b>39</b>
<b>FORD Fiesta Van, 3-dr Hatchback, 08-</b>	<b>34</b>	<b>991</b>	<b>39</b>
<b>FORD Fiesta, 5-dr Hatchback, 08-</b>	<b>33</b>	<b>981</b>	<b>39</b>
<b>FORD Fiesta, 4-dr Sedan, *11-</b>	<b>34,5</b>	<b>997</b>	<b>39 1/4</b>
<b>FORD Fiesta, 5-dr Hatchback, *11-</b>	<b>34,5</b>	<b>997</b>	<b>39 1/4</b>

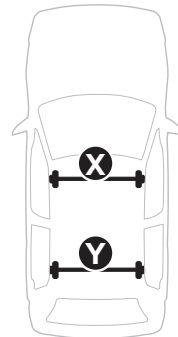
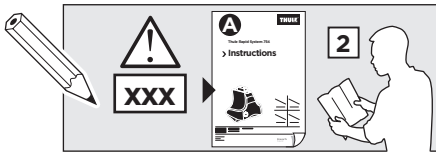

	Y (scale)	Y (mm)	Y (inch)
<b>FORD Fiesta, 3-dr Hatchback, 08-</b>	<b>29,5</b>	<b>946</b>	<b>37 1/4</b>
<b>FORD Fiesta Van, 3-dr Hatchback, 08-</b>	<b>29,5</b>	<b>946</b>	<b>37 1/4</b>
<b>FORD Fiesta, 5-dr Hatchback, 08-</b>	<b>30</b>	<b>951</b>	<b>37 1/2</b>
<b>FORD Fiesta, 4-dr Sedan, *11-</b>	<b>30</b>	<b>953</b>	<b>37 1/2</b>
<b>FORD Fiesta, 5-dr Hatchback, *11-</b>	<b>30</b>	<b>953</b>	<b>37 1/2</b>

2

SRA

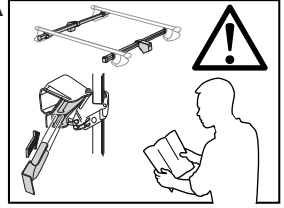

FORD Fiesta, 3-dr Hatchback, 08-  
FORD Fiesta Van, 3-dr Hatchback, 08-

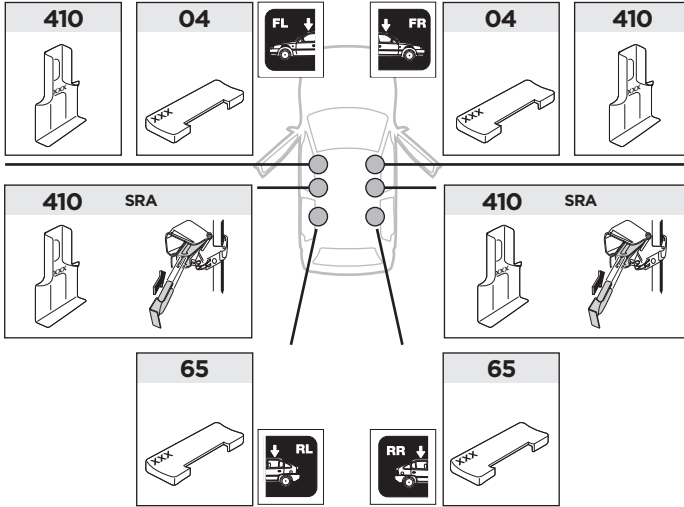

FORD Fiesta, 5-dr Hatchback, 08-  
FORD Fiesta, 4-dr Sedan, \*11-

FORD Fiesta, 5-dr Hatchback, \*11-

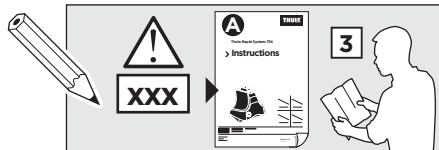
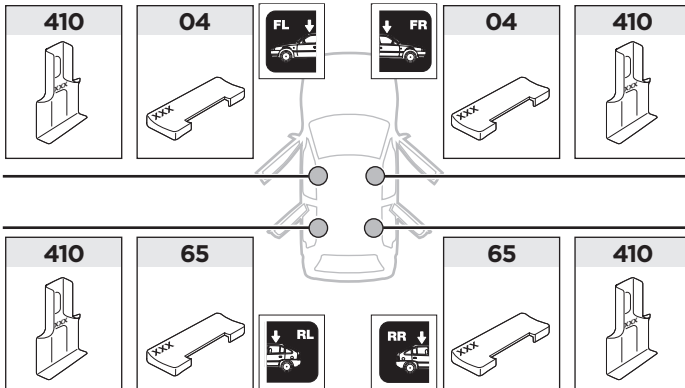

**3**

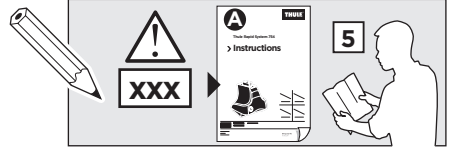

	W (mm)	Z (mm)	Y (mm)	W (inch)	Z (inch)	Y (inch)
<b>FORD Fiesta, 3-dr Hatchback, 08-</b>	<b>250</b>	<b>650</b>	<b>320</b>	<b>9 7/8</b>	<b>25 5/8</b>	<b>12 1/2</b>
<b>FORD Fiesta Van, 3-dr Hatchback, 08-</b>	<b>250</b>	<b>650</b>	<b>320</b>	<b>9 7/8</b>	<b>25 5/8</b>	<b>12 1/2</b>

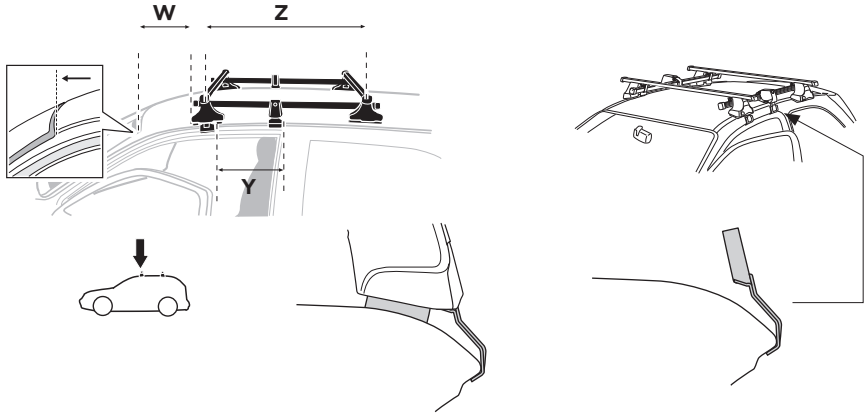

	W (mm)	Z (mm)	W (inch)	Z (inch)
<b>FORD Fiesta, 5-dr Hatchback, 08-</b>	<b>320</b>	<b>600</b>	<b>12 5/8</b>	<b>23 5/8</b>
<b>FORD Fiesta, 4-dr Sedan, *11-</b>	<b>289</b>	<b>610</b>	<b>11 3/8</b>	<b>24</b>
<b>FORD Fiesta, 5-dr Hatchback, *11</b>	<b>289</b>	<b>610</b>	<b>11 3/8</b>	<b>24</b>

